

Oscar the Grouch

1

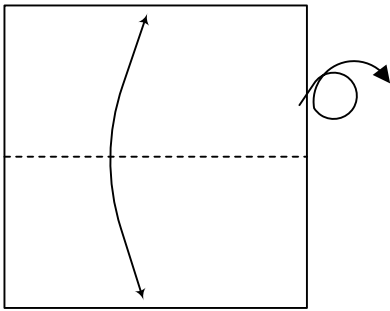

2

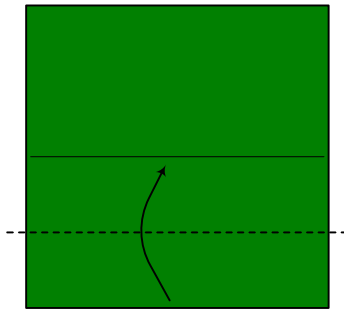

3

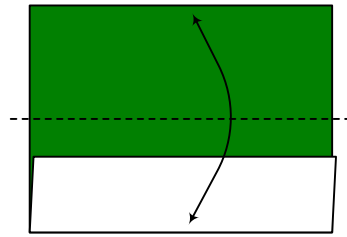

4

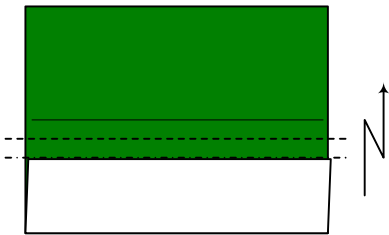

5

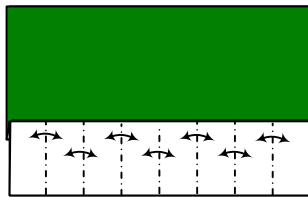

Crease through both layers into 8ths

6

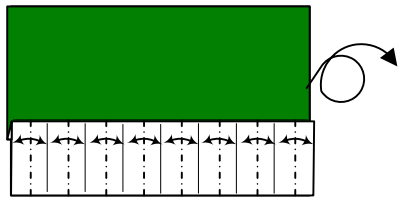

And again into 16ths

7

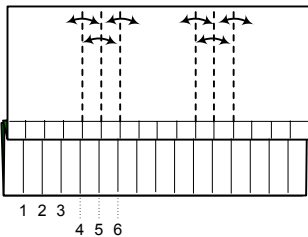

Add a few more creases

8

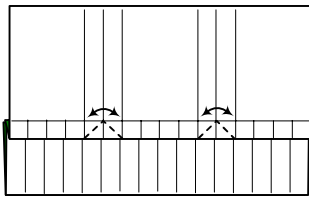

Crease the front 2 layers only

9

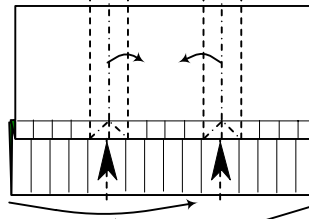

While valley folding the sides, narrow the top part of the model...

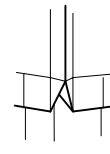

..Like this

12

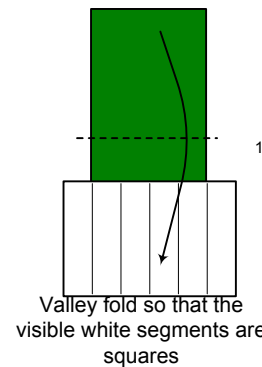

Valley fold so that the visible white segments are squares

13

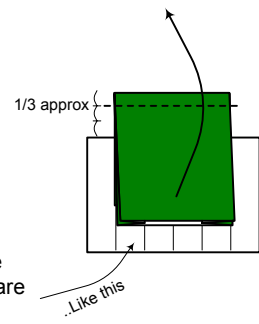

..Like this

10

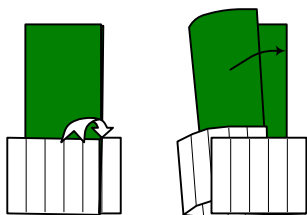

Interlock the edges...

..Like this

11

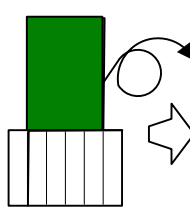

14

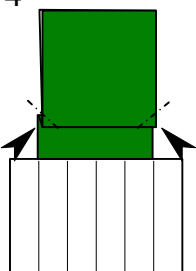

Inside reverse folds

15

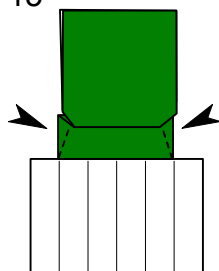

Inside reverse folds

16

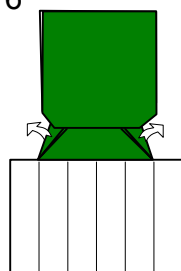

Unfold

17

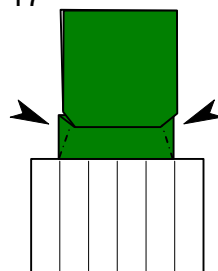

Sink the sides

18

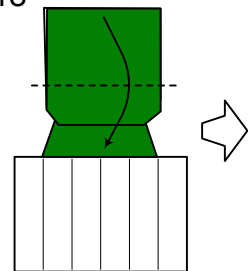

Oscar the Grouch

19

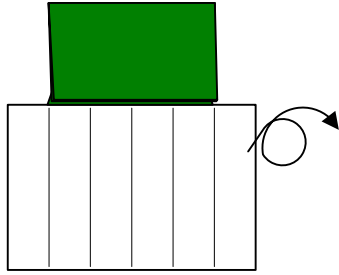

20

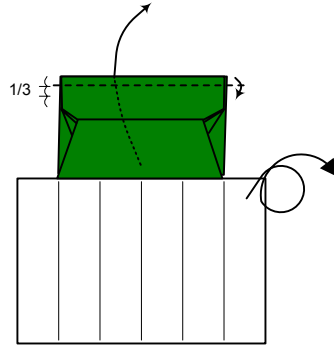

21

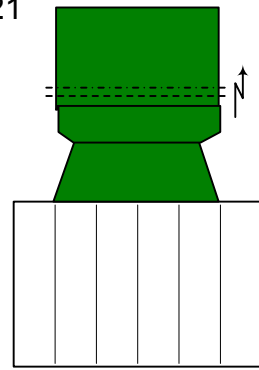

Make a tiny valley and mountain fold to form the top of the mouth

22

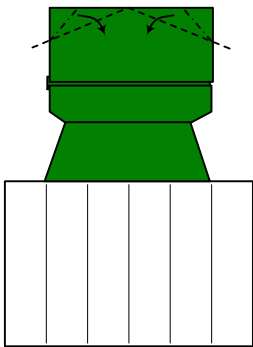

23

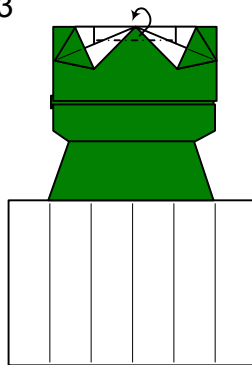

24

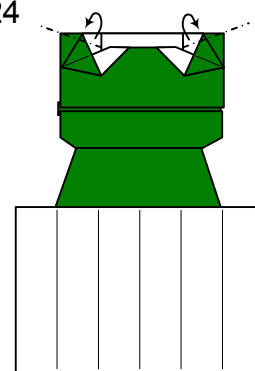

25

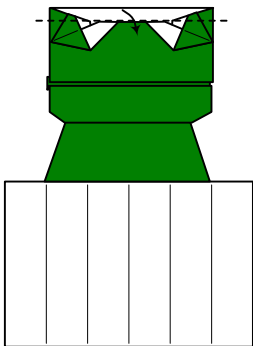

26

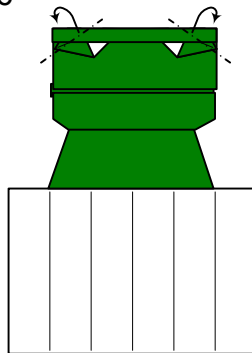

27

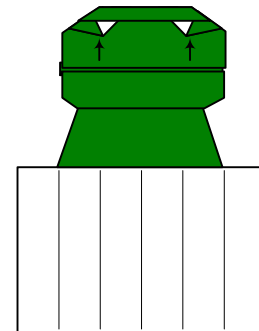

Make the eyes rounder

28

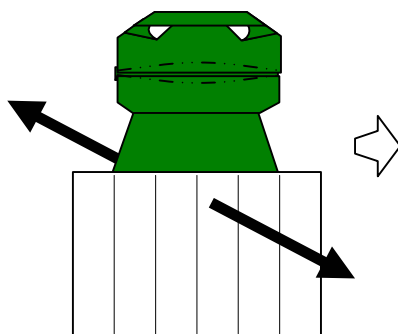

Make the whole model 3d, rounding the trash can and Oscar's mouth

